



Prislista 2007

Alla priser gäller exklusive moms.



Rev. C
2007

Förklaringar till koder i listan

L före art. nr. = **Lagervara**, leveranstid c:a. 1-2 dagar.

B före art. nr. = **Beställningsvara**, leveranstid c:a. **4-8** veckor.

U före art. nr. = **Utgått** ur sortimentet, kan finnas kvar på lager.

P5, P10, P100 etc. i slutet på art. nr. = storlek på förpackningen dvs. **5 st., 10 st., 100 st.** etc.

Sidregister

Sid :	Produkter
2	Lödstationer & Tennsugar
3	Varmluft- och BGA-utrustning
4	Inspektion, kalibrering, lodgryta och tillbehör
5	Lödverktyg och tillbehör
6	Lödspetsar TD100
8	Reparationsspetsar till TD100
9	Reparationsspetsar till MT100, TP100
10	Spetsar till PS80 och PS90
11	Spetsar till SX70, SX80 och SX90
12	Spetsar till SX70, SX80 och TT65
13	Spetsar till TP65, DTP80, TJ70 och TJ80
14	Nosslar till TF200 - TF700, ST300 - ST350
16	Nosslar till TF1500 - TF3000
17	Reservdelar till PS80, PS90 och SX80
18	Reservdelar till SX70

Huvudkontor: Häradsvägen 29
141 43 HUDDINGE

Tel : 08 - 711 70 00

Fax : 08 - 711 70 10





Säljkontor: Neongatan 7
431 54 MÖLNDAL

Tel: 031-706 76 00

E-post : office@desab-elektronik.se

Hemsida : www.desab-elektronik.se

Lödstationer

	Art. nr.	Beskrivning:	Pris ex. moms.
	L 8007-0510	ST 25 E, 230 V med PS90	
	L 8007-0512	ST 30 E, 230 V med TD100	
	L 8007-0514	ST 50 E, 230 V med TD100	
	L 8007-0518	ST 70 E, 230 V med TD100	
	L 8007-0527	ST 100 SYSTEM 230V	

ST - Tennsugar

	Art. nr.	Beskrivning:
	L 8007-0516	ST 65 E, 230 V
	L 8007-0520	ST 75 E, 230 V
	L 8007-0522	ST 115 E, 230 V

MBT reparationsstationer

	Art. nr.	Beskrivning:
	L 8007-0479	MBT 301 med SX80 & TD100
	L 8007-0455	MBT350 med SX80, TD100 & MT100

Varmluft- och BGA-reparation

Art. nr. Beskrivning:



B 8007-0428 **ST300E, Varmluftsstation analog**



B 8007-0432 **ST325E, Varmluftsstation digital**



3 8007-0438 **ST350E, QFP/BGA reparationsutrustning**



B 8007-0436 **ST400E, Fövärmare med IR**



B 8007-0434 **ST450E, Fövärmare med varmluft**



B 6993-0253-P1 **ST525, 305 mm Kort hållare A04**



B 6993-0254-P1 **ST550, 460 mm Kort hållare A04**



B 6993-0258-P1 **ST 500, Stativ till ST300, ST325 A04**



ST350 BGA
ST325 BGA

Paket förslag

ST350 med undervärme (ST350 + ST400)
ST325 med undervärme och stativ
ST325, ST400, ST500, ST550

BGA-reparation



B 8007-0466 **TF 1700, BGA Utrustning**



B 8007-0469 **TF 2700 BGA-utrustning med extra stor undervärme**
B 1340-0174-P1 **K-Type Thermogivare**
B 1121-0927-P1 **Liten vacuum plock för TF1700/2700 0,89mm**

Inspektion



Art. nr. B 8007-0386
Beskrivning: XR 3000 Röntgen utrustning

Övriga produkter



Art. nr. B 8001-0087-P1
Beskrivning: Spets Temperatur Mätare - Y



B K 96
B K 96-1
B K tacktenn
B K tacktenn
B K tacktenn
Lodgryta 50x54x50 (BxHxL)
Lodgryta 70x64x70
1 kg tacktenn 63/37
1 kg tacktenn SAC 305
1 kg tacktenn Låg SAC (99,1 0,2 0,7)

Tillbehör



Art. nr. L 1207-0362-01-P1
L 1207-0362-02-P1
L 1207-0362-03-P1
L 1207-0362-04-P1
L 1207-0362-05-P1
L 1207-0362-06-P1
L 1207-0362-07-P1
L 1207-0362-08-P1
L 1207-0364-P1
Beskrivning: HW Kraftmodul Nr 5 / 260°C
HW Kraftmodul Nr 5,5 / 290°C
HW Kraftmodul Nr 6 / 320°C
HW Kraftmodul Nr 6,5 / 340°C
HW Kraftmodul Nr 7 / 370°C
HW Kraftmodul Nr 7,5 / 400°C
HW Kraftmodul Nr 8 / 430°C
HW Kraftmodul Nr 8,5 / 460°C
TW Kalibrerings modul



Diverse
L 4021-0008-P3 Torksvamp till verktygsställ
L 1121-0382-P5 Sugkopp, 4.95mm
L 1121-0383-P5 Sugkopp, 7.62mm
L 6993-0153-P1 Sugkopps set, 3 storlekar 1 av varje.
L 6021-0007-P1 Redi-Rak, Spetsställ för montering ovanpå MBT-station
L 6021-0008-P1 Redi-Rak, Spetsställ för montering i verktygsställ
2 L 1127-0006-P5 Borste, Stål, Element, 3.2mm
2 L 1127-0014-P5 Borste, Stål, Element 4.8mm



1 L 1127-0002-P5 Borste, Fiber, För Glasrör
3 L 6993-0138 Spets rengöringsstation, komplett
4 L 1100-0232 Fiberborste
5 L 1127-0013-P2 Utbytesborst, Glasfiber
6 L 1100-0233 Svampborste
L 4021-0006-P5 Torksvamp till borste
7 L 4021-0007-P7 Torksvamp till rengöringsstation



8 L 6993-0200 Rensnåls set













9 L 1100-0206 Spetsverktyg, Tång/Skruvmejsel















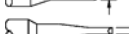
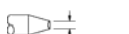

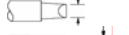
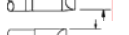
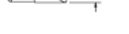
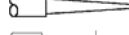



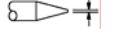
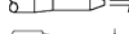
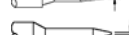











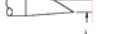
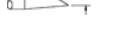





B 1102-0016-P1 TipBrite Spetsförtenning, blyfri

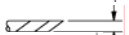



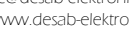





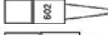
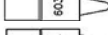
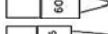
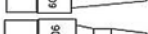

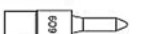

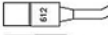
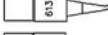

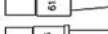

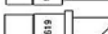

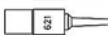

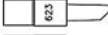
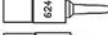
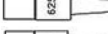





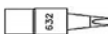
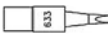
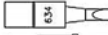
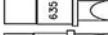
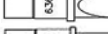

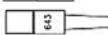

Lödverktyg och tillbehör

	Art. nr.	Beskrivning:
	L 6993-0242-P1	TD100 med Verktygsställ
	B 6993-0263-P1	TD100 Blå (8 PIN)
	L 6010-0132-P1	TD100 Lödpenna
	L 1213-0090-P5	O-ring, Ersättning TD100
	L 3008-0131-P1	Kabel till TC100
	B 6019-0068-P1	Verktygsställ för TD100 A03
	B 6019-0071-P1	Verktygsställ för TD100 m. automatisk avstämning
	B 6993-0281-P1	TD100 m. Verktygsställ automatisk avstämning
	L 1310-0034-P1	Spetslåda för 10st spetsar
	L 1321-0639-P1	HW/TW Spetsställ för 10 spetsar
	B 8887-0100	Lödröks kit till TC100
	L 6993-0243-P1	MT100 med Verktygsställ
	B 6993-0264-P1	MT100 Blå (8 PIN)
	B 6010-0140-P1	MT100 MiniTweezer lödpincett
	B 6019-0069-P1	Verktygsställ för MT100 A03
	B 1119-0165-P2	SOFT GRIP, MT100, PKG/2 A03
	B 6993-0280-P1	TP100 ThermoPik med Verktygsställ
	B 6010-0158-P1	TP100
	L 6993-0199-P1	PS90 med Verktygsställ
	B 6993-0267-P1	PS90 Blå (8 PIN)
	B 6010-0131-P1	PS90 Lödpenna
	L 6010-0095-P1	Element PS90, 21V, 50W
	L 1348-0547-P10	Skruv för SensaTemp element (1/90 eller senare)
	L 6993-0213-P1	SX80 med Verktygsställ
	B 6993-0266-P1	SX80 Blå (8 PIN)
	L 6010-0106-P1	SX80 Tennsug
	L 6010-0107-P1	Element SX80
	L 1309-0054-P10	SX80 Papphyllsa / Tennbehållare, 10-pack
	L 1309-0054-P100	SX80 Papphyllsa / Tennbehållare, 100-pack
	L 6000-0212-P1	SX80 Startkit för glasrör
	L 1265-0011-P1	SX80 Glasrör
	L 4010-0115-P2	V-baffel till SX80 glasrör
	L 1309-0018-P10	Glasrörs filter, 10-pack
	L 1309-0018-P50	Glasrörs filter, 50-pack
	L 1309-0027-P10	VisiFilter disk, 10-pack
	L 1309-0027-P50	VisiFilter disk, 50-pack
	L 1309-0028-P1	VisiFilter II, utbytbart
	L 1213-0086-P1	Bakre packning, SX80
	L 1213-0087-P1	Främre packning, SX80 element
L 6993-0200	Rensnäls set	
L 1348-0547-P10	Skruv för SensaTemp element (1/90 eller senare)	
	B 6993-0227-P1	SX70 med Verktygsställ
	B 6010-0077-P1	SX 70 Tennsug
	L 6010-0080-P1	Element SX70
	L 1265-0009-P1	SX70 Glasrör
	L 4010-0033	"S" plåtbleck för glasrör
	L 1309-0018-P10	Glasrörs filter, 10-pack
	L 1309-0018-P50	Glasrörs filter, 50-pack
	L 1309-0027-P10	VisiFilter disk, 10-pack
	L 1309-0027-P50	VisiFilter disk, 50-pack
	L 6993-0200	Rensnäls set
	L 1348-0547-P10	Skruv för SensaTemp element (1/90 eller senare)
	L 6993-0207-P1	TT65 ThermoTweezer med Verktygsställ
	B 6993-0268-P1	TT65 Blå (8 PIN)
	L 6010-0082-P1	Element TT65 med sensor
	L 6010-0083-P1	Element TT65 utan sensor
	L 1348-0547-P10	Skruv för SensaTemp element (1/90 eller senare)
	L 6993-0205-P1	TP65 ThermoPik med Verktygsställ
	L 6010-0081-P1	Element TP65
	L 1348-0547-P10	Skruv för SensaTemp element (1/90 eller senare)
	L 6993-0183	DTP-80 Dual ThermoPik med ställ
	L 6010-0082-P1	Element TT65 med sensor
	L 6010-0083-P1	Element TT65 utan sensor
	L 1348-0547-P10	Skruv för SensaTemp element (1/90 eller senare)
	L 6993-0206-P1	TJ70 ThermoJet med Verktygsställ
	L 6010-0084-P1	Element TJ70
	L 1348-0547-P10	Skruv för SensaTemp element (1/90 eller senare)
	L 6993-0247-P1	TJ80 med Verktygsställ
	B 6993-0270-P1	TJ80 Blå (8 PIN)
	B 6010-0142-P1	TJ80 Varmluftspenna
	B 6010-0143-P1	TJ80 Element

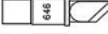
Spetsar till TD100

TD	Art. nr.	Beskrivning:
	Staffling 5-9 st. Staffling 10- st.	Pris per styck vid köp av min 5 st spetsar av samma sort. Pris per styck vid köp av min 10 st spetsar av samma sort.
	L 1124-0012-P1	0,80mm, Mejselspets
	L 1124-0008-P1	1,20mm, Mejselspets
	L 1124-0019-P1	1,60mm, Mejselspets
	L 1124-0007-P1	1,60mm, Mejselspets, Förlängd
	L 1124-0017-P1	1,60mm, Mejselspets
	L 1124-0014-P1	2,00mm, Mejselspets
	L 1124-0013-P1	2,40mm, Mejselspets
	L 1124-0020-P1	3,20mm, Mejselspets
	L 1124-0023-P1	3,20mm, Mejselspets, Förlängd
	L 1124-0010-P1	5,15mm, Mejselspets
	L 1124-0036-P1	0,19mm, Konisk spets
	L 1124-0002-P1	0,40mm, Konisk spets
	L 1124-0004-P1	0,40mm, Konisk spets, Förlängd
	L 1124-0006-P1	0,60mm, Konisk spets
	L 1124-0027-P1	0,60mm, Konisk spets
	L 1124-0005-P1	0,80mm, Konisk spets
	L 1124-0030-P1	0,80mm, Konisk spets
	L 1124-0001-P1	0,80mm, Konisk spets, Förlängd
	L 1124-0018-P1	0,80mm, Konisk spets, Förlängd
	L 1124-0022-P1	1,60mm, Konisk spets
	L 1124-0025-P1	1,60mm, Konisk spets, Förlängd
	L 1124-0042-P1	0,25mm, Microfine Konisk spets
	L 1124-0043-P1	0,75mm, Microfine Konisk spets böjd
	L 1124-0044-P1	0,5mm, Microfine Konisk spets böjd
	L 1124-0015-P1	0,40mm, Böjd konisk spets, Förlängd
	L 1124-0003-P1	0,40mm, Böjd konisk spets
	L 1124-0021-P1	0,60mm, Böjd konisk spets
	L 1124-0028-P1	1,20mm, Böjd mejselspets, Förlängd
	L 1124-0016-P1	1,20mm, Böjd mejselspets
	L 1124-0026-P1	1,60mm, Böjd mejselspets
	L 1124-0035-P1	3,04mm, MiniWave, Vinklad
	L 1124-0033-P1	6,35mm, MiniWave, Vinklad
	L 1124-0032-P1	6,35mm, MiniWave
	L 1124-0034-P1	6,35mm, Elipsformad
	L 1124-0038-P1	1,5mm, Mini elipsformad
	L 1124-0039-P1	1,5mm, MiniWave, vinklad
	L 1124-0040-P1	0,9mm, Mini elipsformad
	L 1124-0041-P1	1,1mm, Mini elipsformad
	L 1124-0045-P1	Micro wave spets böjd
	L 1124-0046-P1	Micro wave spets
	L 1124-0047-P1	1,3mm, vinklad mejsel
	L 1124-0048-P1	8mm, MiniWave
	L 1124-0011-P1	0,40mm, Fasadspets 60°
	L 1124-0029-P1	0,80mm, Fasad spets 30°
	L 1124-0009-P1	1,20mm, Fasadspets 30°
	L 1124-0024-P1	1,60mm, Fasad spets 60°
	L 1124-0037-P1	6,35mm, Platt blad
	L 1124-0031-P1	4,00mm, Värmeformning

Spetsar till TD100 DIAMANT Plätering

Art. nr.	Beskrivning:
	Staffling 5-9 st. Pris per styck vid köp av min 5 st spetsar av samma sort. Staffling 10- st. Pris per styck vid köp av min 10 st spetsar av samma sort.
	L 1126-0601-P1 Spets, Diamant,0.4mm Konisk
	L 1126-0602-P1 Spets, Diamant,1.0mm Konisk
	L 1126-0603-P1 Spets, Diamant,1.4mm Konisk Trubbig
	L 1126-0604-P1 Spets, Diamant,0.8mm Konisk Trubbig
	L 1126-0605-P1 Spets, Diamant,0.4mm Konisk Lång
	L 1126-0606-P1 Spets, Diamant,0.4mm Konisk Smal
	L 1126-0607-P1 Spets, Diamant,0.4mm Konisk Smal Förlängd
	L 1126-0608-P1 Spets, Diamant,0.6mm Konisk Smal
	L 1126-0609-P1 Spets, Diamant,1.0mm Konisk Smal
	L 1126-0610-P1 Spets, Diamant,0.8mm Konisk Smal
	L 1126-0611-P1 Spets, Diamant,1.2mm Konisk Smal
	L 1126-0612-P1 Spets, Diamant,1.0mm Konisk Smal Böjd
	L 1126-0613-P1 Spets, Diamant,0.4mm Konisk Trubbig Böjd
	L 1126-0614-P1 Spets, Diamant,0.4mm Konisk Trubbig
	L 1126-0615-P1 Spets, Diamant,0.4mm Konisk Förlängd Böjd
	L 1126-0616-P1 Spets, Diamant,4.0mm Snedskuren 45
	L 1126-0617-P1 Spets, Diamant,2.0mm Snedskuren 60
	L 1126-0618-P1 Spets, Diamant,3.0mm Snedskuren 60
	L 1126-0619-P1 Spets, Diamant,4.0mm Snedskuren 45 Förtennt
	L 1126-0620-P1 Spets, Diamant, Snedskuren 60 Smal Förlängd
	L 1126-0621-P1 Spets, Diamant,1.0mm Snedskuren 45 Förtennt
	L 1126-0622-P1 Spets, Diamant,2.0mm Snedskuren 45 Förtennt
	L 1126-0623-P1 Spets, Diamant,3.0mm Snedskuren 45 Förtennt
	L 1126-0624-P1 Spets, Diamant,1.0mm Snedskuren 45
	L 1126-0625-P1 Spets, Diamant,1.6 x 3.2mm Oval Snedskuren 60
	L 1126-0626-P1 Spets, Diamant,1.8mm Snedskuren 60
	L 1126-0627-P1 Spets, Diamant,2.0mm Snedskuren 45
	L 1126-0628-P1 Spets, Diamant,3.3mm Snedskuren 60
	L 1126-0629-P1 Spets, Diamant,3.0mm Snedskuren 45
	L 1126-0630-P1 Spets, Diamant,0.6mm Snedskuren Spec
	L 1126-0631-P1 Spets, Diamant,0.8mm Mejsel
	L 1126-0632-P1 Spets, Diamant,1.2mm Mejsel
	L 1126-0633-P1 Spets, Diamant,1.6mm Mejsel
	L 1126-0634-P1 Spets, Diamant,2.4mm Mejsel
	L 1126-0635-P1 Spets, Diamant,4.0mm Mejsel
	L 1126-0636-P1 Spets, Diamant,5.2mm Mejsel
	L 1126-0637-P1 Spets, Diamant,4.0mm Mejsel, Lång
	L 1126-0638-P1 Spets, Diamant,5.2mm Mejsel, Lång
	L 1126-0639-P1 Spets, Diamant,2.0mm Mejsel Trubbig
	L 1126-0640-P1 Spets, Diamant,3.2mm Mejsel Trubbig
	L 1126-0641-P1 Spets, Diamant,1.4mm Mejsel Böjd
	L 1126-0642-P1 Spets, Diamant,1.6mm Mejsel Böjd
	L 1126-0643-P1 Spets, Diamant,1.4mm Mejsel Förlängd Böjd
	L 1126-0644-P1 Spets, Diamant,4.7mm Kniv 45
	L 1126-0645-P1 Spets, Diamant,4.6mm Kniv 45
	L 1126-0646-P1 Spets, Diamant,4.7mm Kniv 45 Trubbig
	L 1126-0647-P1 Spets, Diamant,4.8mm Kniv 45
	L 1126-0648-P1 Spets, Diamant,2.0mm Snedskuren Mejsel

Reparationsspetsar till TD100

Art. nr.

Beskrivning:

Chip / SOT reparation

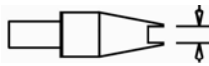

B 1124-0518-P1	2.2mm, Chip 0402, 0805, 1206, Vinklad
B 1124-0533-P1	0.5mm, Chip 0201, Vinklad
B 1124-0520-P1	5.0mm, Chip 1808
B 1124-0521-P1	1.0mm, Chip 0402
B 1124-0534-P1	0.5mm, Chip 0201
B 1124-0522-P1	1.8mm, SOT-23
B 1124-0523-P1	2.8mm, SOT-89
B 1124-0524-P1	3.6mm, Chip 1206
B 1124-0525-P1	2.4mm, Chip 0805

SOIC / SOP / TSOP reparation

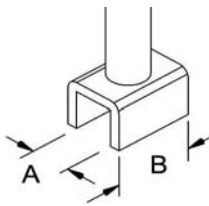

innermått och sida

B 1124-0519-P1	5.10mm x 4.65mm, SOIC-8
B 1124-0504-P1	5.2mm x 10.5mm, SOIC-14, -16
B 1124-0505-P1	9.6mm x 13.6mm, SOIC-20
B 1124-0506-P1	10.8mm x 18.6mm, SOP-28
B 1124-0507-P1	11.9mm x 25.7mm, SOP-40
B 1124-0508-P1	13.1mm x 28.4mm, SOP-44
B 1124-0509-P1	18.8mm x 14.1mm, TSOP-56
B 1124-0510-P1	12.0mm x 8.50mm, TSOP-28
B 1124-0526-P1	18.8mm x 10.4mm, TSOP-40

PLCC / QFP reparation

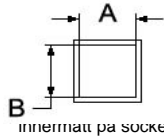

innermått på sockel





B 1124-0528-P1	7.6mm x 12.8mm, PLCC-18
B 1124-0515-P1	11.8mm x 11.8mm, PLCC-28
B 1124-0511-P1	9.30mm x 9.30mm, PLCC-28 Sockel
B 1124-0512-P1	14.2mm x 11.7mm, PLCC-32
B 1124-0513-P1	16.8mm x 16.8mm, PLCC-44
B 1124-0530-P1	19.4mm x 19.4mm, PLCC-52
B 1124-0529-P1	12.5mm x 12.5mm, TQFP-80
B 1124-0537-P1	15.3mm x 15.3mm TQFP-64
B 1124-0535-P1	15.5mm x 15.5mm TQFP-100
B 1124-0514-P1	20.6mm x 20.6mm, QFP-144
B 1124-0516-P1	22.0mm x 16.0mm, QFP-100/128
B 1124-0531-P1	26.6mm x 26.6mm, QFP-100

Blad spetsar



B 1124-0536-P1	6.7mm, Bladspets
B 1124-0501-P1	10,8 mm, Bladspets
B 1124-0502-P1	16,0 mm, Bladspets
B 1124-0503-P1	21,2 mm, Bladspets
B 1124-0532-P1	25.0mm, Bladspets





















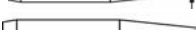
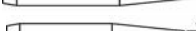

Reparationsspetsar till MT100

MT	Art. nr.	Beskrivning:
	B 1124-1001-P1	Chip 0,2 mm
	B 1124-1002-P1	Chip, SOT's 0,7 x 0,5 mm
	B 1124-1003-P1	Chip, SOT's 0,7 x 1 mm
	B 1124-1004-P1	Chip, SOT's 0,7 x 2 mm
	B 1124-1005-P1	SOIC, SOT's, TSOP's 0,7 x 6 mm
	B 1124-1006-P1	SOIC, SOT's, TSOP's 0,7 x 8 mm
	B 1124-1007-P1	SOIC, SOT's, TSOP's 0,7 x 10 mm
	B 1124-1008-P1	SOIC, SOT's, TSOP's 0,7 x 13 mm
	B 1124-1009-P1	TIP,MINITWEEZ, SOP 18MM A04
	B 1124-1010-P1	TIP,MINITWEEZ, SOP 28MM A04

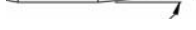

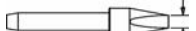

Reparationsspetsar till TP100

	Art. nr.	Beskrivning:
	B 1124-2001-P1	LQFP/TQFP 32, 40 TIP
	B 1124-2002-P1	LQFP/TQFP 32, 48, 52, 64 TIP
	B 1124-2003-P1	LQFP/TQFP 44, 52, 64, 80 TIP
	B 1124-2004-P1	LQFP/TQFP 80 TIP
	B 1124-2005-P1	LQFP/TQFP 64, 80, 100, 120, 128, 168 TIP
	B 1124-2006-P1	LQFP/TQFP 100, 120, 128 TIP
	B 1124-2007-P1	LQFP/TQFP 128, 144, 160, 176 TIP
	B 1124-2008-P1	LQFP/TQFP 176, 216 TIP
	B 1124-2009-P1	LQFP/TQFP 208, 256 TIP
	B 1124-2010-P1	QFP 44, 52, 64 TIP
	B 1124-2011-P1	QFP 52, 64, 80, 100 TIP

Spetsar till PS80 & PS90

	Art. nr.	Beskrivning:
	L 1121-0359-P5	0.8mm, Mejselspets
	L 1121-0414-P5	1.6mm Mejselspets
	L 1121-0335-P5	1.6mm, Mejselspets
	L 1121-0499-P5	1.60 mm, Mejselspets, Förlängd
	L 1121-0533-P5	1.60mm, Mejsel, Förlängd
	L 1121-0349-P5	1.60 mm, Mejselspets, Extra tunn
	L 1121-0360-P5	2.4mm, Mejselspets
	L 1121-0529-P5	2.40 mm, Mejselspets, Förlängd
	L 1121-0337-P5	3.2mm, Mejselspets
	L 1121-0358-P5	4.8mm, Mejselspets
	L 1121-0357-P5	0.4 mm, Konisk spets
	L 1121-0528-P5	0.4 mm, Konisk spets, Förlängd
	L 1121-0336-P5	0.8mm, Konisk spets
	L 1121-0527-P5	0.80 mm, Konisk spets, Förlängd
	L 1121-0361-P5	0.8mm, Mejselspets, Böjd
	B 1121-0830-P5	0.40 mm, Konisk spets, Böjd smal
	L 1121-0510-P5	1.60 mm, Mejselspets, Thermo-Drive
	L 1121-0518-P5	3.20 mm, Mejselspets, Thermo-Drive
	L 1121-0563-P5	1.50 mm, Elipsformad spets, Vinklad
	L 1121-0564-P5	1.80 mm, Mini-Wave, Vinklad
	L 1121-0610-P5	2.40 mm, Mini-Wave, Vinklad, Long life
	L 1121-0406-P5	3.30 mm, Elipsformad spets
	L 1121-0490-P5	3.30mm, Skälad Mini-Wave
	L 1121-0402-P1	6.60 mm, Plattblad
	L 1121-0305-P1	10.2mm, Platt blad

Reparations spetsar till PS80 och PS90

	Art. nr.	Beskrivning:
	L 1121-0390-P1	5.05mm x 5.05mm, SOIC-8
	L 1121-0391-P1	5.05mm x 8.99mm, SOIC-14
	L 1121-0392-P1	5.05mm x 10.20mm, SOIC-16
	L 1121-0303-P1	Avlödning CHIP<3.56mm 1206
	L 1121-0403-P1	19.3mm x 8.1mm, TSOP-spets

innermått och sida

Spetsar till SX70 & SX80

Art. nr.	Beskrivning:
	Inner diameter x Ytter diameter
L 1121-0625-P5	0.76mm x 2.03mm, Thermo-Drive
L 1121-0624-P5	1.02mm x 2.29mm, Thermo-Drive
L 1121-0626-P5	1.52mm x 3.05mm, Thermo-Drive
L 1121-0627-P5	2.29mm x 5.10mm, Thermo-Drive
B 1121-0821-P5	Platt huvud, Thermo-Drive
L 1121-0628-P5	0.76mm x 2.29mm, Förlängd Thermo-Drive
L 1121-0629-P5	1.02mm x 2.54mm, Förlängd Thermo-Drive
L 1121-0630-P5	1.52mm x 3.05mm, Förlängd Thermo-Drive
L 1121-0680-P5	0.50mm x 1.79mm, Precision
L 1121-0678-P5	0.76mm x 2.03mm, Precision
B 1121-0916-P5	0,63 mm, Precision
L 1121-0679-P5	1.02mm x 2.29mm, Precision
L 1121-0690-P5	1.52mm x 2.79mm, Precision
U 1121-0695-P5	2.29mm x 3.55mm, Precision
L 1121-0631-P5	1.52mm x 4.78mm, Pad rengöring
L 1121-0681-P5	0.50mm x 1.79mm, Flo-D-Sodr
B 1121-0917-P5	0,63mm, Fine Precision
L 1121-0682-P5	0.76mm x 2.03mm, Flo-D-Sodr
L 1121-0683-P5	1.02mm x 2.29mm, Flo-D-Sodr

Provpaket

1121-app14-sug	1121-0624, 1.02mm x 2.29mm, Thermo-Drive 1121-0625, 0.76mm x 2.03mm, Thermo-Drive 1121-0626, 1.52mm x 3.05mm, Thermo-Drive 1121-0627, 2.29mm x 5.10mm, Thermo-Drive
1121-app15-sug	1121-0628, 0.76mm x 2.29mm, Förlängd Thermo-Drive 1121-0629, 1.02mm x 2.54mm, Förlängd Thermo-Drive 1121-0630, 1.52mm x 3.05mm, Förlängd Thermo-Drive 1121-0631, 1.52mm x 4.78mm, Pad rengöring





Spetsar till SX90

Art. nr.	Beskrivning:
	Inner diameter x Ytter diameter
L 1121-0930-P5	0.76mm x 2.03mm, Thermo-Drive
L 1121-0931-P5	1.02mm x 2.29mm, Thermo-Drive
L 1121-0932-P5	1.52mm x 3.05mm, Thermo-Drive
L 1121-0933-P5	2.29mm x 5.10mm, Thermo-Drive
L 1121-0951-P5	4mm x 5.10mm, Thermo-Drive
L 1121-0934-P5	1.52mm x 4.78mm, Thermo-Drive Pad rengöring
L 1121-0935-P5	0.76mm x 2.29mm, Förlängd Thermo-Drive
L 1121-0936-P5	1.02mm x 2.54mm, Förlängd Thermo-Drive
L 1121-0937-P5	1.52mm x 3.05mm, Förlängd Thermo-Drive
L 1121-0938-P5	0.76mm x 2.03mm, ThermoMax
L 1121-0939-P5	1.02mm x 2.29mm, ThermoMax
L 1121-0940-P5	1.52mm x 3.05mm, ThermoMax
L 1121-0941-P5	0.50mm x 1.79mm, Precision
L 1121-0942-P5	0.76mm x 2.03mm, Precision
L 1121-0943-P5	1.02mm x 2.29mm, Precision
L 1121-0944-P5	1.52mm x 2.79mm, Precision
L 1121-0949-P5	0.63mm x 1.39mm, Precision
L 1121-0950-P5	0.63mm x 1.14mm, Precision
L 1121-0945-P5	1.52mm x 4.78mm, Pad rengöring
L 1121-0946-P5	0.50mm x 1.79mm, Flo-D-Sodr
L 1121-0947-P5	0.76mm x 2.03mm, Flo-D-Sodr
L 1121-0948-P5	1.02mm x 2.29mm, Flo-D-Sodr

Provpaket

1121-app16-sug	1121-0930, 0.76mm x 2.03mm, Thermo-Drive 1121-0931, 1.02mm x 2.29mm, Thermo-Drive 1121-0932, 1.52mm x 3.05mm, Thermo-Drive 1121-0933, 2.29mm x 5.10mm, Thermo-Drive 1121-0951, 4mm x 5.10mm, Thermo-Drive
1121-app17-sug	1121-0935, 0.76mm x 2.29mm, Förlängd Thermo-Drive 1121-0936, 1.02mm x 2.54mm, Förlängd Thermo-Drive 1121-0937, 1.52mm x 3.05mm, Förlängd Thermo-Drive 1121-0934, 1.52mm x 4.78mm, Pad rengöring

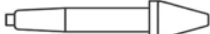

Spetsar till SX70

	Art. nr.	Beskrivning:
		Inner diameter x Ytter diameter
	L 1121-0367-P5	0.76mm x 1.52mm, Thermo-Drive
	L 1121-0342-P5	1.02mm x 1.78mm, Thermo-Drive
	L 1121-0368-P5	1.52mm x 2.54mm, Thermo-Drive
	L 1121-0494-P5	1.02mm x 2.16mm, Förlängd Thermo-Drive
	L 1121-0506-P5	1.52mm x 2.69mm, Förlängd Thermo-Drive
	L 1121-0463-P5	1.02mm x 2.16mm, Long-life
	L 1121-0464-P5	1.52mm x 2.69mm, Long-life
	L 1121-0369-P5	1.52mm x 4.77mm, Pad rengöring

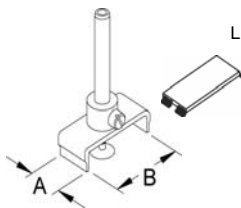
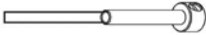
Reparationspetsar till SX70 & SX80

	L 1121-0566-P1	A x B 8.1mm x 19.3mm, TSOP-32
sida och inermått		
	L 1360-0286-P5	Adapter för Micro spetsar till SX70 och SX80

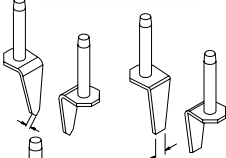
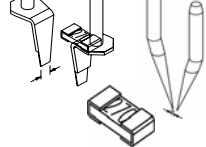
Spetsar till TT65 ThermoTweezer

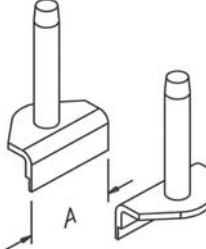
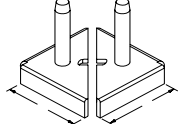
		Säljs i par (P1 = 2st spetsar)
	U 1121-0398-P1	0.76mm, Chip spets
	L 1121-0313-P1	2.0mm, Chip spets
	L 1121-0399-P1	4.1mm, Chip spets
	L 1121-0401-P1	6.4mm, Chip/SOIC spets
	L 1121-0520-P1	0.76mm, Chip spets, Tunn vägg
	L 1121-0521-P1	2.00mm, Chip spets, Tunn vägg
	L 1121-0517-P1	0.43mm, Vinklad chip spets
	L 1121-0512-P1	SOIC 7.60 mm, Bred bladspets
	L 1121-0514-P1	10.2 mm, Bred bladspets
	L 1121-0473-P1	12.7 mm, Bred bladspets
	L 1121-0416-P1	17.8mm, Bred bladspets
	L 1121-0497-P1	20.3 mm, Bred bladspets
	L 1121-0442-P1	25.4 mm, Bred bladspets
	B 3018-0129-P1	Värmeskydd
	L 1121-0316-P1	PLCC spetsar 6.86mm x 6.86mm, PLCC-20
	L 1121-0317-P1	9.40mm x 9.40mm, PLCC-28
	L 1121-0352-P1	12.2mm x 9.65mm, PLCC-32
	L 1121-0318-P1	14.5mm x 14.5mm, PLCC-44 / PQFP-80
	L 1121-0319-P1	17.0mm x 17.0mm, PLCC-52 / PQFP-100
	L 1121-0320-P1	21.9mm x 21.9mm, PLCC-68 / PQFP-132
	L 1121-0321-P1	26.9mm x 26.9mm, PLCC-84 / PQFP-160
Längd på sida		

Spetsar till TP65 ThermoPik

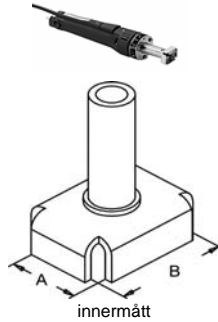

Art. nr.	Beskrivning:
L 1121-0322-001P1	15.5mm x 21.6mm, PQFP
L 1121-0322-002P1	16.8mm x 22.9mm, PQFP-80/100
L 1121-0323-P1	15.7mm x 15.7mm, PQFP-68
L 1121-0484-P1	15.7mm x 15.7mm, PQFP-64/80
L 1121-0324-P1	18.3mm x 18.3mm, PQFP-84
L 1121-0325-P1	20.8mm x 20.8mm, PQFP-100
L 1121-0326-P1	25.6mm x 25.6mm, PQFP-132
L 1121-0456-P1	29.2mm x 29.2mm, PQFP-144
L 1121-0544-P1	30.0mm x 30.0mm, PQFP-208
L 1121-0351-P1	31.0mm x 31.0mm, PQFP-160
L 1121-0483-P1	36.3mm x 36.3mm, PQFP-196

Spetsar till DTP80 DualThermoPik

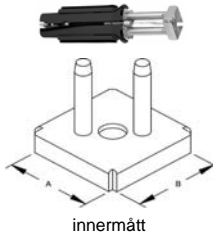

U 1121-0549-P1	20.8mm x 20.8mm, PQFP-100
U 1121-0551-P1	25.9mm x 25.9mm, PQFP-132
U 1121-0553-P1	29.2mm x 29.2mm, PQFP-144
U 1121-0557-P1	30.0mm x 30.0mm, PQFP-208
U 1121-0552-P1	31.0mm x 31.0mm, PQFP-160/208
U 1121-0558-P1	33.8mm x 33.8mm, PQFP-240
U 1121-0554-P1	36.3mm x 36.3mm, PQFP-196
U 1121-0593-P1	42.4mm x 42.4mm, PQFP-304

Vakuumpipor

L 1121-0382-P5	Sugkopp, 4.95mm
L 1121-0383-P5	Sugkopp, 7.62mm
L 6993-0153-P1	Sugkopps set, 3 storlekar 1 av varje.

Munstycken till TJ70 ThermoJet

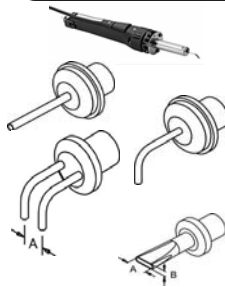

L 1121-0366-P1	1.52mm, Rak Rund
L 1121-0338-P1	1.52mm, Böjd Rund
L 1121-0330-P1	4.32mm, Dual-Jet, SOIC
U 1121-0331-P1	9.40mm, Dual-Jet, SOICL
L 1121-0365-P1	7.1mm x 1.8mm, Platt munstycke
L 1121-0371-P1	6.1mm x 1.8mm, Platt munstycke

Munstycken till TJ80 ThermoJet



B 1259-0129-P1	Munstycke TJ80 rund rak, 2 mm
B 1259-0130-P1	Munstycke TJ80 rund Böjd, 2 mm
B 1259-0131-P1	Munstycke TJ80 platt, 6x2 mm

Utgående Spetsar

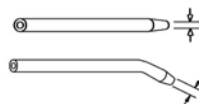

U 1121-0255-P5	1.52mm, Micro
U 1121-0261-P5	0.76mm, Micro Böjd
U 1121-0262-P5	1.02mm, Micro Böjd

Reservation för slutförsäljning

Nosslar till TF200 - TF700 och ST300 - ST350



Art. nr.	Beskrivning:
	<i>Ingår med en monteringsmall</i>
Art. nr.	Beskrivning:
B 4028-0001	Adapter till Nozzlar
B 4028-5501	7.75mm x 5.60mm, µBGA-48
B 4028-5502	7.85mm x 6.40mm, µBGA-48
B 4028-5010	8.64mm x 8.90mm, BGA-18
B 4028-5008	10.42mm x 10.42mm, BGA-32
B 4028-5009	11.97mm x 13.21mm, BGA-40/44
B 4028-5004	13.0mm x 13.0mm, BGA-144
B 4028-5007	13.45mm x 14.97mm, BGA-68
B 4028-5005	15.0mm x 15.0mm, BGA-121/196
B 4028-5022	16.0mm x 16.0mm, BGA-100
B 4028-5006	16.25mm x 17.75mm, BGA-86
B 4028-5015	17.0mm x 17.0mm, BGA-256
B 4028-5036	17.0mm x 17.0mm, Kort adapter.
B 4028-5025	18.5mm x 18.5mm, BGA-196
B 4028-5019	19.0mm x 19.0mm, BGA-96/121
B 4028-5024	19.25mm x 19.25mm, BGA-169
B 4028-5016	21.0mm x 21.0mm, BGA-252/255/256
B 4028-5017	21.0mm x 21.0mm, Kort adapter.
B 4028-5037	21.0mm x 21.0mm, Liten kopp
B 4028-5035	21.0mm x 25.0mm, BGA-303
B 4028-5023	22.0mm x 24.0mm, BGA-119
B 4028-5032	22.0mm x 22.0mm, BGA-169
B 4028-5002	23.0mm x 23.0mm, BGA-169/168
B 4028-5011	25.0mm x 25.0mm, BGA-292/357/361
B 4028-5028	25.0mm x 32.3mm, BGA-475
B 4028-5026	26.4mm x 26.4mm, BGA-240
B 4028-5001	27.0mm x 27.0mm, BGA-204/255/226/272/292/320/324
B 4028-5021	29.0mm x 29.0mm, BGA-256/400
B 4028-5027	30.0mm x 30.0mm, BGA-256
B 4028-5014	31.0mm x 31.0mm, BGA-240/304/432
B 4028-5020	32.0mm x 32.0mm, BGA-240/324
B 4028-5033	33.0mm x 33.0mm, BGA-361
B 4028-5003	35.0mm x 35.0mm, BGA-313/352
B 4028-5018	37.5mm x 37.5mm, BGA-479/493/584
B 4028-5012	40.0mm x 40.0mm, BGA-421/432/736
B 4028-5013	42.5mm x 42.5mm, BGA-560
B 4028-5029	43.0mm x 43.0mm, BGA-521
B 4028-5030	44.0mm x 44.0mm, BGA-540
B 4028-5034	47.5mm x 47.5mm, BGA-720



SOIC-nosslar	
B 4028-4001	4.1mm x 6.1mm, SOIC-8
B 4028-4002	4.1mm x 10.9mm, SOIC-14/16
B 4028-4003	7.9mm x 10.9mm, SOICL-16
B 4028-4004	7.9mm x 13.5mm, SOICL-20
B 4028-4005	7.9mm x 16.0mm, SOICL-24
B 4028-4006	7.9mm x 18.5mm, SOICL-28
B 4028-4007	11.68mm x 20.83mm, SOICL-32
B 4028-4008	SOJ 40/42
B 4028-4505	18.6mm x 18.6mm, TSOP-48
B 4028-4506	10.4mm x 21.35mm, TSOP-32/40/44/50

Nosslar till TF200 - TF700 och ST300 - ST350



Art. nr.

Beskrivning:

Singel Jet-nosslar

Art. nr.

Beskrivning:

- | | |
|-------------|---------------------|
| B 4028-1001 | Ø 3.0mm, Böjd, Rund |
| B 4028-1002 | Ø 5.0mm, Böjd, Rund |
| B 4028-1003 | Ø 8.0mm, Böjd, Rund |
| B 4028-1011 | Ø 3.0mm, Rak, Rund |
| B 4028-1012 | Ø 5.0mm, Rak, Rund |
| B 4028-1013 | Ø 8.0mm, Rak, Rund |
| B 4028-1021 | 13.21mm bred, Platt |
| B 4028-1022 | 23.37mm bred, Platt |



PLCC / QFP-nosslar

- | | |
|-------------|--------------------------------------------------|
| B 4028-1501 | 44mm x 30mm, |
| B 4028-2001 | 8.5mm x 12.1mm, PLCC-18 (ej med baffel) |
| B 4028-2002 | 10.2mm x 10.2mm, PLCC-20 (ej med baffel) |
| B 4028-2003 | 12.8mm x 12.8mm, PLCC-28 (ej med baffel) |
| B 4028-2004 | 12.8mm x 15.3mm, PLCC-32 (ej med baffel) |
| B 4028-2005 | 17.9mm x 17.9mm, PLCC-44 (ej med baffel) |
| B 4028-2006 | 20.4mm x 20.4mm, PLCC-52 |
| B 4028-2007 | 25.5mm x 25.5mm, PLCC-68 |
| B 4028-2008 | 30.6mm x 30.6mm, PLCC-84 |
| B 4028-2009 | 38.9mm x 38.9mm, PLCC-100 |
| B 4028-2501 | 18.1mm x 24.1mm, QFP-80/100 |
| B 4028-2502 | 17.0mm x 17.0mm, QFP-64/80 (ej med baffel) |
| B 4028-2503 | 26.9mm x 26.9mm, QFP-132 |
| B 4028-2504 | 31.9mm x 31.9mm, QFP-160 |
| B 4028-2505 | 31.5mm x 31.5mm, QFP-208 |
| B 4028-2506 | 34.6mm x 34.6mm, QFP-240 |
| B 4028-2507 | 27.1mm x 27.1mm, BQFP-100 |
| B 4028-2508 | 21mm x 21mm, BQFP-84 |
| B 4028-2602 | 27.1mm x 27.1mm, BQFP-132 |
| B 4028-3002 | 11.5mm x 11.5mm, TQFP-32 (ej med baffel) |
| B 4028-3004 | 15.5mm x 15.5mm, TQFP-120 (ej med baffel) |
| B 4028-4505 | 18.6mm x 18.6mm, TSOP-48 |
| B 4028-4506 | 10.4mm x 21.35mm, TSOP-32/40/44/50 |
| B 4028-5001 | 27.0mm x 27.0mm, BGA-204/255/226/272/292/320/324 |
| B 4028-5002 | 23.0mm x 23.0mm, BGA-169/168 |
| B 4028-5003 | 35.0mm x 35.0mm, BGA-313/352 |
| B 4028-5004 | 13.0mm x 13.0mm, BGA-144 |
| B 4028-5005 | 15.0mm x 15.0mm, BGA-121/196 |
| B 4028-5006 | 16.25mm x 17.75mm, BGA-86 |
| B 4028-5007 | 13.45mm x 14.97mm, BGA-68 |
| B 4028-5008 | 10.42mm x 10.42mm, BGA-32 |
| B 4028-5009 | 11.97mm x 13.21mm, BGA-40/44 |
| B 4028-5010 | 8.64mm x 8.90mm, BGA-18 |

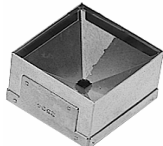

Nossel med baffel



Nossel utan baffel

Nosslar till TF1500 - TF3000

Art. nr.	Beskrivning:
B 4038-7001	5 x 5 mm
B 4038-7002	6 x 8 mm
B 4038-7003	8,2 x 12,7 mm
B 4038-7004	9 x 9 mm
B 4038-7005	10 x 10 mm
B 4038-7006	13 x 13 mm
B 4038-7007	15 x 15 mm
B 4038-7008	17 x 17 mm
B 4038-7009	23 x 23 mm
B 4038-7010	27 x 27 mm
B 4038-7011	35 x 35 mm
B 4038-7012	44,5 x 44,5 mm
B 4038-7013	22 x 22 mm LQFP
B 4038-7014	16 x 16 mm LQFP
B 4038-7015	30 x 30 mm LQFP
B 4038-7016	9 x 9 mm LQFP
B 4038-7017	12 x 12 mm LQFP
B 4038-7018	26 x 26 mm LQFP
B 4038-7019	22 x 16 mm
B 4038-7020	14 x 14 mm LQFP
B 4038-7021	14 x 20 mm
B 4038-7022	50 x 50 mm
B 4038-7023	60 x 60 mm
B 4038-7024	40 x 40 mm
B 4038-7025	25 x 25 mm
B 4038-7026	19 x 19 mm
B 4038-7027	16,5 x 8 mm
B 4038-7028	33 x 33 mm
B 4038-7029	21 x 25 mm
B 4038-7030	29 x 29 mm
B 4038-7031	31 x 31 mm
B 4038-7032	42 x 42 mm
B 4038-7033	16 x 13 mm
B 4038-7034	27 x 13 mm
B 4038-7035	30 x 12 mm
B 4038-7036	19 x 8 mm
B 4038-7037	56 x 17 mm
B 4038-7038	28 x 16 mm med baffel
B 4038-7039	13 x 10 mm
B 4038-7040	7,3 x 7 mm
B 4038-7041	8 x 8 mm
B 4038-7042	6 x 6 mm
B 4038-7043	44 x 44 mm
B 4038-7044	30 x 30 mm
B 4038-7045	43 x 43 mm
B 4038-7046	46 x 46 mm
B 4038-7047	41 x 41 mm
B 4038-7048	28 x 28 mm
B 4038-7049	48 x 48 mm
B 4038-7050	11,4 x 5,1 mm
B 4038-7051	32,5 x 23 mm
B 4038-7052	11 x 17 mm
B 4038-7053	17 x 32 mm
B 4038-7054	42,5 x 32,5 mm
B 4038-7055	8,1 x 8,1 mm
B 4038-7056	32,5 x 25 mm
B 4038-7057	22 x 22 mm
B 4038-7058	20 x 8 mm
B 4038-7059	28,5 x 17 mm
B 4038-7060	21 x 12,75 mm
B 4038-7061	20 x 20 mm
B 4038-7062	15,6 x 5,1 mm
B 4038-7063	15,34 x 12,7 mm
B 4038-7064	44 x 33 mm
B 4038-7066	38,1 x 25,8 mm
B 4038-7069	75 x 75 mm
B 4038-7070	14 x 10 mm
B 4038-7071	37 x 37 mm
B 4038-7072	17 x 23 mm
B 4038-7074	16 x 22 mm
B 4038-7075	14,5 x 14,5 mm
B 4038-7081	8 x 9 mm
B 4038-7082	61 x 41 mm
B 4038-7083	54 x 17 mm
B 4038-7084	13 x 15 mm
B 4038-7085	7 x 6 mm
B 4038-7086	9 x 7,5 mm
B 4038-7087	11 x 10 mm
B 4038-7088	14 x 11 mm
B 4038-7089	12 x 12 mm
B 4038-7090	7 x 6 mm
B 4038-7094	NOZZLE, SOCKET,SRT CUSTOM A04

Reservdelar till PS80 och PS90

Art. nr.	Beskrivning:
1 L 1348-0547-P10	Skruv för SensaTemp element (1/90 eller senare)
2 B 1410-0122-P5	HTR RETAINING NUT,PS-90/70
3 L 6010-0095-P1	ASSY,HEATER,21VAC,50W,PS-80A

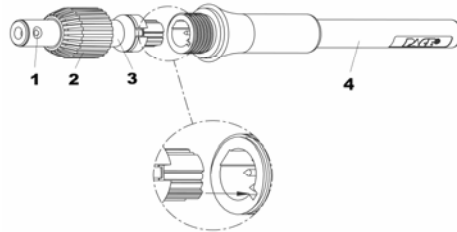

Reservdelar till SX80 och SX90

Art. nr.	Beskrivning:
1 L 1309-0054-P10	SX80 Papphylsa / Tennbehållare, 10-pack
1 L 1309-0054-P100	SX80 Papphylsa / Tennbehållare, 100-pack
2 L 6010-0115-P1	Reserv handtag SX80 med kretskort och kabel
3 B 1119-0141-P1	Hyllshållare
4 L 6010-0107-P1	Element SX80
5 L 1213-0087-P1	Främre packning, SX80 element
6 L 1213-0086-P1	Bakre packning, SX80
7 B 1261-0154-P1	Vakuumsrör
8 B 1500-0063-P1	Rörlås
9 L 1348-0387-P3	Ryttare, 3 stycken
10 B 1221-0136-P1	Fjäder "Långa sidan"
11 B 1221-0137-P1	Fjäder "Korta sidan"
12 B 1119-0142-P1	Ändstopp
13 L 1348-0547-P10	Skruv för SensaTemp element (1/90 eller senare)
L 6000-0212-P1	SX80 Startkit för glasrör
L 1265-0011-P1	SX80 Glasrör
L 4010-0115-P2	V-baffel till SX80 glasrör
L 6993-0200	Rensnåls set
L 1309-0028-P1	VisiFilter II, utbytbart
L 1309-0027-P10	VisiFilter disk, 10-pack
L 1309-0027-P50	VisiFilter disk, 50-pack

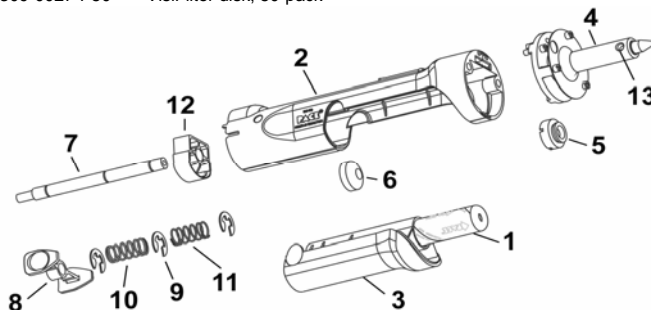

Reservdelar till SX70

Art. nr.	Beskrivning:
1 L 1265-0009-P1	SX70 Glasrör
2 L 6010-0080-P1	Element SX70
3 L 1213-0033-P1	Främre packning, SX70
4 L 1213-0001-P1	Bakre packning, SX70
5 L 4010-0106-P1	Rörlås
6 L 1360-0005	Värmesköld element handtag
7 B 1313-0115	Täckplast för kretskort
8 B 6993-0140	Plastdelar handtag ink. Skruvar, klipps och värmesköld
10 L 4010-0098-P1	Kretskort och kabel
11 B 1209-0006-P5	Handtags klips
12 B 1119-0119-P1	Tryckknapp
13 L 1348-0547-P10	Skruv för SensaTemp element (1/90 eller senare)
14 B 1405-0534-P3	Skruv för fastsättning av värmesköld
15 B 1405-0395-P3	Skruv för fastsättning av element
16 B 1213-0072-P10	Lod skydd (medföljer alla element)
17 L 4010-0033	"S" plåtbleck för glasrör
18 L 1309-0018-P50	Glasrörs filter, 50-pack
19 B 1309-0020-P1	Visifilter limmad
20 L 1309-0028-P1	VisiFilter II, utbytbar
21 L 1309-0027-P50	VisiFilter disk, 50-pack
22 L 1342-0015-08	Slang för SX svart 54"
23 B 1321-0085-01-P6	SUPPORT TOOL, BASE
24 L 1259-0086-P1	Slang koppling hona
25 L 1259-0087-P1	Slang koppling hane

